

Instruction manual

MAH
MAS2
MAK
MAE

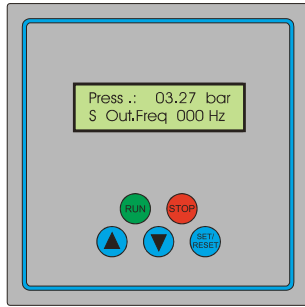

MAI

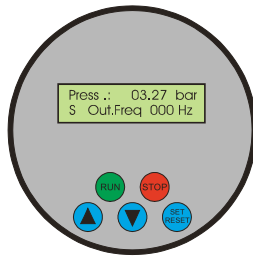

Pump-Controller :

Pressure regulation System for Pumps

MA.... Software version 7.00

Table of contents	Page
1. Safety Precautions	2
2. General / Mode of Operation	4
3. Installation and Mounting	5
4. Wiring and Connections	6
5. Keys and Display	9
6. Display Functions and Initial Settings	10
7. Operating Indicators / menu / Startup	12
8. Trip history monitor	25
9. Expert mode	30
10. Clear presentation of the menu structure MA	34
11. Customer Settings	35
12. Technical execution, terminal diagram, schematic of the respective controller	

1. Safety Precautions

Before installing and commissioning of the frequency converter controller, please read the product manual carefully and observe all warnings and safety instructions. Keep this manual is always easily accessible in the vicinity of the frequency converter controller.

Definition of Information



Warning!

In disregard of the safety instructions may lead to serious and life-threatening bodily injury or property damage occur, a significant!



Caution!

Failure to observe these instructions may lead to serious and life-threatening bodily injury or property damage occur, a significant!

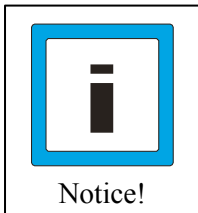

Notice!

Failure to observe these instructions may lead to malfunction of the plant!



Warning!

The frequency inverter controller generates dangerous electrical voltages and controls potentially dangerous rotating mechanical parts.



Warning!

The installation, Initial Settings and maintenance of these drives can only be by qualified personnel who are familiar with the operation, carried out.



Warning !

Give special care when automatic restart is enabled. To prevent injuries caused by any inadvertent restart of inverter controller after a power failure, turn off in case of doubt the automatic restart. For repair and maintenance work at the plant, you notice that the system can not be turned on by other again!



Warning!

The frequency inverter controllers have the lead after the mains off dangerously high voltage. Wait, therefore, after switching off the mains for at least 5 minutes before you work on the device. It is important to ensure that no live parts are touched, or when voltage is applied between the capacitors are charged. Do not work on the wiring and make sure no signals when voltage is applied.



Caution!

All frequency controllers are tested for dielectric strength and insulation resistance. Be disconnected before the isolation measurement on the pump unit, for example, as part of the inspection, the frequency control!



Warning!

Warning!

The drive - controller has a leakage current. Ground the frequency - Controller at the designated ports.

The customer's RCCB must be an in-MAH, MAS2, MAK, MAE - dial to pole sensitive / selective RCCB tripping with type B be 300 mA.

The customer's RCCB must be a the MAI - dial to pole sensitive RCCB type B with his tripping 30 mA.

It is recommended to secure the separate frequency - control.

Observe the regional regulations for electrical installation!



Warning!

Warning!

Make sure that the input voltage corresponds to the nameplate voltage registered.



Caution!

Caution!

Environmental conditions such as high temperatures, high humidity should be avoided as well as dust, dirt and corrosive gases. The installation should be a well-ventilated and not exposed to direct sunlight location.



Caution!

Caution!

Do they no mains power to the sensor terminals or to the control terminals.

Caution!

Enter the operating signals START / STOP button on the control panel on or about the triggering of the external contacts and not by turning on and off a mains or motor contactor.



Caution!

Caution!

It is strongly recommended that all electrical equipment conforms to the National Electrical Codes and local regulations. Only qualified personnel should perform installation, alignment and maintenance. The manufacturer reserves the right to alter the technical data in order to make improvements or update information.



Notice!

Notice!

The technical data and descriptions in this guide are correct to the best knowledge and belief. Technical improvements have been continuously carried out - that's why the manufacturer reserves the right, without prior notice to carry out such changes.

The manufacturer can not be held liable for errors in the manual.

Warranty is within Germany and within the incorporated statutory warranty period and applies only to the product itself and not for any consequential loss or damage or costs associated with the occurrence of a Warranty claim arise at other plants or plant parts. The operator shall, in each case to ensure that a failure or defect in the product can not lead to further damage.

2. General / Mode of Operation

2.1 MA Pressure Control System

Congratulations on purchasing this high-quality pump control. This product complies with the latest technology and is continually developed and improved. The device was subjected to the production of an extensive examination and therefore functions properly. To read to ensure optimal function and observe these operating instructions.

This frequency inverter controller operates as an automatic pressure regulator, tested. The speed of the pump (s) will be adjusted continuously. The actual pressure in the system is determined by pressure transducer (sensor). A PI controller regulates the pressure by analogy.

The pressure regulator is programmable and can be adapted to the respective operating conditions. The parameters are displayed on the display in plain text. Commissioning is menu driven. During commissioning, some data must be entered to ensure the smooth operation of the pumping plant. An adjustment of specific parameters (expert mode) requires special knowledge of pump technology. This should be done by a competent person or the manufacturer.

2.2 Benefits of speed control:

- almost constant pressure
- Continuous adjustment of pump power to the changing operating conditions
- Energy saving
- a speed-double unit replaces a four-fold pressure switch system
- low mechanical wear of the pumps
- Maintenance

2.3 Principles of speed control

To operate a speed control can be accurately and effectively, the following points to consider:

- the pump (s) must be construed in accordance with the plant / Requirement
- the pump (s) shall have power reserves available (80. .90%) = system reserve capacity at rating
- Submersible Pumps in the frequency or operating range between 30. .99 (200) Hz should be restricted (hydrodynamic bearing)
- with submersible pumps must be based on an output reduction of about 5. .10%

2.4 Construction of a pressure control system

Non-return valve preventer is imperative and must be in the pressure behind the Pump will be installed! The expansion tank is to be fitted if required.



Achtung!

1 Flow direction	2 Controller
3 Motor	4 Pump
5 Non-return valve	6 Pressure Transducer
7 Pressure vessel	

Example 1 pump System

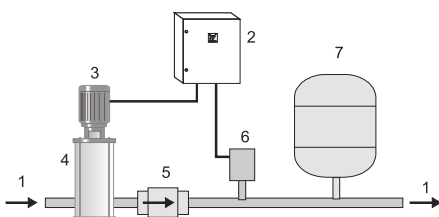

Example 2 pumps System

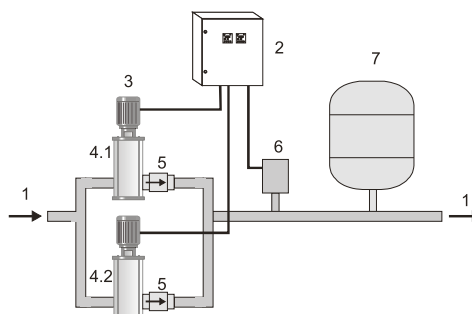

2.5 Note for the operation of the system with Pressure vessel!

If the plant is operated with a pressure vessel, the vessel must be pre-pressed in normally state. The pre-squeezing pressure should be checked regularly. The amount of pre-squeezing pressure is: Start pressure bar minus 0.20.

e.g.:	Nominal System Pressure:	4.00 bar
	Vessel Air Pressure:	3.80 bar

2.6 Booster Sets



Notice!

Booster units are ready plumbed and wired pump installations. For them, the installation cost is minimal - connect to the existing network of pipes, mains and commissioning. The regulator is factory set at these facilities.

This manual refers only to the electrical control of the system is therefore possibly the pump consult the manual (s) note the / partition.

See manufacturers data sheet.

3. Installation and Mounting



Caution!

Environmental conditions such as high temperatures, high humidity should be avoided as well as dust, dirt and corrosive gases. The installation should be a well-ventilated and not exposed to direct sunlight location.

Because of convection, the frequency control during installation of at least Be installed 15 cm from side walls or other facilities.



Warning!

The allowable temperature range of +5 ° C to +30 ° C must not be under-or exceeded.

Do not install the Inverter controller near heat-radiating bodies.

3.1 Mounting the MA.... Controller

Metal box:

In the rear contains holes for wall mounting of the cabinet.
The sole assembly recommended hung stud to the electrical cabinet.

Mounting Dimensions: See manufacturers data sheet MAS2, MAH.

Compact box:

In the rear there are 4 holes with $d = 7$ mm for wall mounting the switch box.
Mounting Dimensions: See manufacturers data sheet MAK, MAE.

Motor controller:

The motor controller is mounted on a pump
Mounting Dimensions: See manufacturers data sheet MAI, pump manufacturers.

4. Wiring and Connections



Warning!

Make sure that the input voltage corresponds to the nameplate voltage registered.



Caution!

Be sure to supply voltage and terminal assignment instructions!

The installation, commissioning and maintenance of the actuators may be of an expert who is familiar with the pump system will be implemented.



Warning!

Do they no mains power to the sensor - or control terminals.

No manipulation of the sensor signal to make!

No other users connect to the 24V supply!

The used pressure sensor (0. .10 V) or (4. .20 mA),
is connected to the respective terminals!

The respective pin assignment, refer to the respective diagram.



Notice!

In systems with several pumps are used again and 0. .10 V sensors.

Here you can optionally one or more sensors are connected.

The respective pin assignment, refer to the respective diagram.



Caution!

Notice!

If the motor cable longer than 100 meters, it is advisable to install an motor reactor.

Caution!

Verify the correct connection of the network, sensor, and control lines.

4.1 Motor Protection

The MA ... Frequency control has a monitoring function for the motor current.
As a special design thermistor to monitor temperature can be employed.

4.2 Connection of inputs / outputs

The lower part of the cubicle MAH MAS2 is the terminal strip
In the lower part of switch box MAK, MAE is the terminals.
In the terminal box are the MAI terminals.

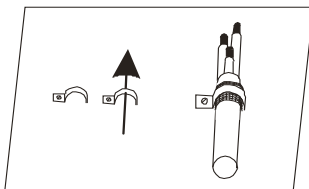

The line to the pump, the sensor cable and wires for the external contacts must be provided with shielded cable and are connected to the adjacent principle with the grounding clamps. Expose The shielding and fasten by means of the grounding clamp on rail. Only with proper installation of the screen trouble-free operation is guaranteed!

4.3 Terminals

When power supply, alarm relay, relay (option), external inputs (option), external outputs (option), sensor (s), pump (s), they face each diagram or schematic or picture of each terminal controller: MAH, MAS2, MAC, MAE, MAI on.

4.4 Power supply

Clamp	Function	Description
PE	Power Supply	PE Ground
L1		L1 Phase
L2	400V AC	L2 Phase
L3		L3 Phase
N		N Neutral
or:		
PE	Power Supply	PE Ground
L1		L1 Phase
N	230V AC	N Neutral

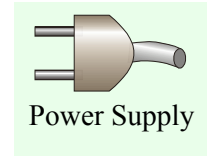

4.5 Connects to the alarm relay

Function	Description
Potential-free	Alarm contact AL 0
Alarm relay	Alarm contact AL 1
230V 1 A	Alarm contact AL 2

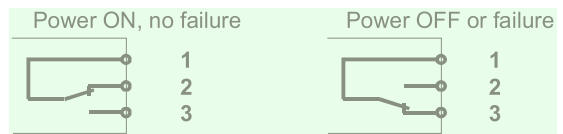

4.6 Port for the two Register relays (Option)

Function	Description
Potential-free	contact 11A (Option MAS2,MAI)
Register relay	contact 11C (Option MAS2,MAI)
230V 1 A 1	contact 12A (Option MAH)
Register relay	contact 12C (Option MAH)

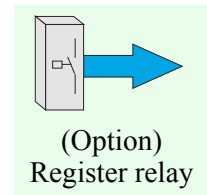

4.7 Port for the external inputs

Function	Description
external „Start“	Ext. 1
external „Fix speed“ / „Reset“	Ext. 2
low water	Ext. 3
limit function	Ext. 4
external „trip“	Ext. 5
set point 2	Ext. 6
Reference voltage	P24 VDC +
Reference voltage	L VDC -
PTC	PTC 1
PTC	PTC 2

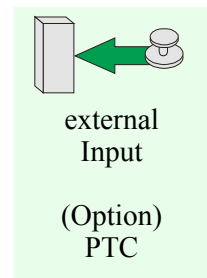

Caution!

Use shielded cable and connect it to the grounding clamps in the cabinet! The maximum length of the control lines may not exceed 20 meters.

Ext. 1: Can be used for an external „Start“ command to give.

Activation of this input on the control panel, see „Running command“.

Ext. 2: Can be used to drive the pump in manual mode - see „fix speed“.

Ext. 2: Short controlling for „External Reset“ intrusion.

Ext. 3: External input error „Low water“ **(Option only MAH)**

Ext. 4: External input „Limit function“ **(Option only MAH)**

Ext. 5: External input „external trip“ **(Option)**

Ext. 6: External input „set point 2“ for a second target pressure **(Option only MAH)**

4.8 Port for the external outputs

Function

rotating analog signal (Option)

rotating analog signal (Option)

Option

Option

Description

Out 1 +

Out 2 -

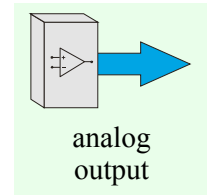

Caution!

Use shielded cable and connect it to the grounding clamps in the cabinet! The maximum length of the control lines may not exceed 20 meters.

Out 1: rotating analog signal 0-10V = 0-100%.

Out 2: rotating analog signal 0-10V = 0-100%

4.9 Port for the transducer

Funktion

Description

Reference voltage P24 VDC +

Reference voltage L VDC -

Transducer signal O 0-10V (MAH, MAS2, MAK, MAE, MAI)

Transducer signal OI 4-20mA (MAH)

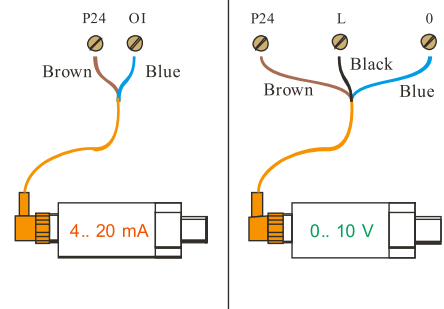

Caution!

Use shielded cable and connected to the grounding clamps in the cabinet!

Note terminal assignment (see the sensor Type plate)!

4.5 Port for the motor / pump

Clamp

Function

U 3 phase motor

V see the

W Type plate

Description

U1

V1

W1

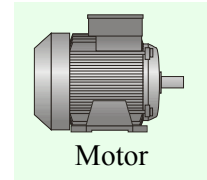

Caution!

Motors must be connected corresponding the output voltage (230V or 400V): Star- or Delta- connection (motor terminal board)! Output voltage = input voltage.

Caution!

Verify the correct connection of the network, transducer, and control lines.

Check before switching on the mains again all connections are correct!

4.6 Frequent installation failures

- Sensor is connected wrong
- Sensor is not installed in the pressure pipe behind the non-return valve
- Non-return valve is not installed or not installed in the right direction
- Pipes/pumps are not ventilated
- Wrong running direction
- Motor terminal board is connected wrong (output voltage! Star- or Delta- connection?)

For faults please the notes under 8.4. Troubleshooting note!

5. Keys and Display

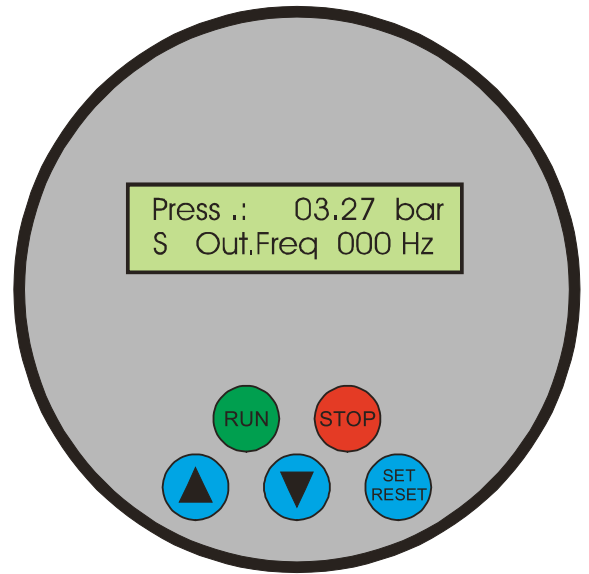
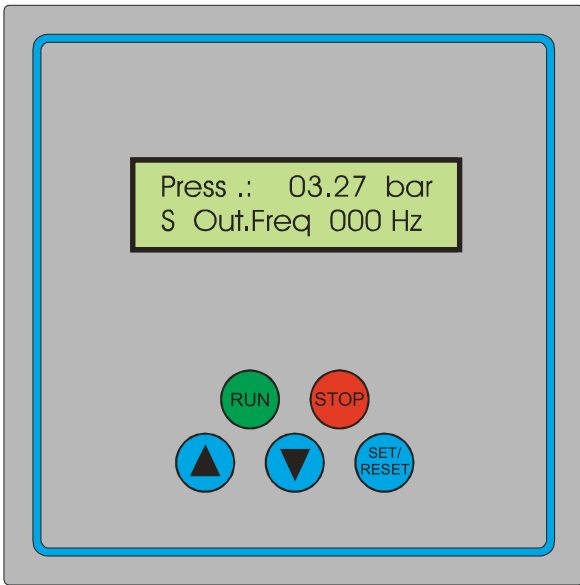

**For multiple pump sets: Each pump has its own display.
The same parameter changes must be made to all pumps/displays.**

**Panel
with two-line LCD display to show the parameters and operating data.**



RUN key

This key is used for starting. (When external start is used, this key does not work.)



STOP key

This key is used for stopping the pump operation and to escape the parameter mode.



UP key, down key

These keys are used for changing data and parameters (to scroll).



SET/RESET key

Pressing this key after setting data and parameters will memorise the settings.
Also used or resetting error messages.

Output Display:

```
R: Run
S: Stop
E: External off
```

Main active display at "external" set point

```
S: 0.00 I:00.00b
S Istfreq: 000Hz
```

Main active display at "internal" set point

```
Press.: 03.27bar
S Out.Freq: 000Hz
```

6. Display Functions and Initial Settings

6.1 Keys

If the output side of the  button pressed, we come to: **set points (code 174)**. Here are the values of the control be adjusted.

If the -button is pressed again, it is to come: **set points (code 815)**. Here are the operating parameters of the controller are set.

If the output side of the solenoid  - button, we arrive at the various operational indicators.

Pressing the  - key to display the next menu indicator.

Is activated in the menu page "operating hours", the  - button, so you come to **Fault memory** (see "error").

From the **failure of memory** must be operated  - button to return to the standby mode.

In the main menu is the pressure regulation by the press  - button to **start**.

Should the plant be run through an external command (see „**Running command**“), this button has no function!

Pressing the Stop  - key the pump will stop. (In „External Start“ does not function!)

Pressing the stop  - key is turned to the main menu.



Notice!

The pump control MA can be optimally adapted to all possible operating conditions by setting different functions and operating parameters in each case. The system is programmed at the time of delivery, so that the cost of commissioning the spot to a minimum. To enter the necessary data for each operating parameter can be a menu item called. The menu items are invoked as described above. For each parameter includes a setting in which either select an option or a range of values can be set.

6.2 Requirements for the commissioning of the MA Controller

Before the control is put into operation, the following requirements must be met:

- Control / pump suction and discharge side connected to the pipeline!
- Piping and pumps are primed!
- Electrical connection is made and reviewed!

6.3 The first time the frequency converter controller

Caution!

If the Autostart function is selected or Saftystart, it comes after switching on the mains or a power outage to automatically restart the pumps!

Switch Controller!

After turning the main switch / voltage of the operational data stored in the frequency converter controller are synchronised. The following message appears on the display:

```
MA.... -Control  
Version: 7.XX
```

If the function „Autostart“ to be selected, it is pointed out

```
Caution!  
Autostart
```

If the function "Saftystart" to be selected, it is pointed out:

Select the master

```
R Saftystart M  
Sec:0059 IF:30Hz
```

Select the slave

```
R Saftystart  
Wait IF:00Hz
```



Is completed after the „Autostart“ or „Saftystart“ appears the original operating display:

Main active display at "external" set point

```
S: 0.00 I:00.00b  
S Istfreq: 000Hz
```

Main active display at "internal" set point

```
Press.: 03.27bar  
S Out.Freq: 000Hz
```

Between the activity lights can be changed using the arrow keys  and .

7. Operating Indicators / menu / Startup

7.1 Select display ads

With the arrow  - button displays the next screen.
By pressing the same arrow key the next screen is displayed.

With the arrow  - button displays the previous display.



Caution!

If the display is "operating hours" message and presses the arrow  - button, so you get the error memory.

From the failure of memory must be set/reset  -button are pressed to return to the standby mode.



Notice!

If the arrow  button is now activated, so you get to the Startup.

Status displays:

Operational Status:

Pressure, Output Frequency (not for external reference input)

```
Press.: 03.27bar
S Out.Freq: 000Hz
```



Nominal pressure, actual pressure: (only for external reference input)

```
S: 0.00 I:00.00b
S Out.Freq: 000Hz
```



Date and time::

```
Press.: 03.27bar
S 13:52 09.05.09
```



Speed, motor current:

```
Speed: 0000n
S M.Curr. 000.0A
```



1. Experts page:

```
P 000 LF 00 50
S1 0.00 DF 00 50
```



2. Experts page: (only Multi- pumps system)

```
SO 3.70 ST 3.20S1
S1 0.00 LF00 DF00
```



Memory status:

Operating hours counter:

```
Operation hours:
S 00000h
```



Error memory :1-6 with date stamp

```
ER63 Sensor error
13.25 10.04.09
```



Notice! The error memory will leave with a Set / Reset  -button.

7.2 Start menu setting

If the arrow  -key pressed after turning on the controller, so you get to the **Start up**.

Operational Status:

Manual mode (Fix speed): If it is necessary, the pump (s) to operate with a fixed speed () such as a breakdown of the sensor can activate the "fix speed".



Once the menu item „fix speed“ with the  -key has been selected, displays a blinking cursor.

With the cursor key  or  on „ON" and confirm with key .

The manual operation is activated immediately. The frequency with which the pump is in manual mode, it can - as described below - are set.

The pump (s) works when there is the start command RUN ( - button). („External start" even possible!)

To disable the manual mode again: press  - button for 2 seconds.

Pressing the run -  or stop-  button is operated the pump in manual mode.
(In „External Start" External started.)

Pressing the Set / Reset button will return to the main menu.

Manual operation

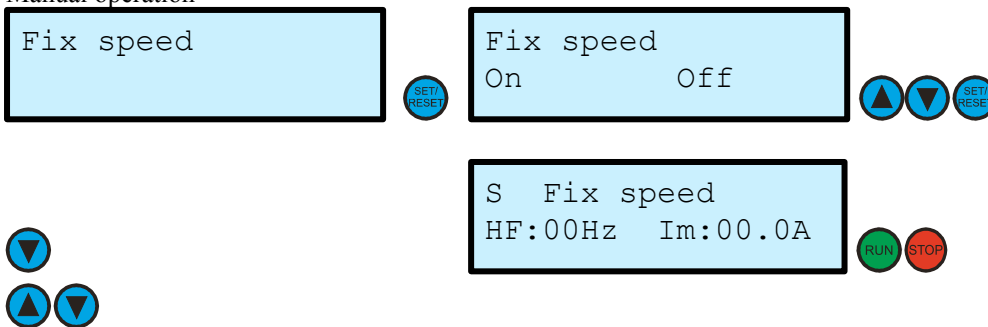

Setting the time

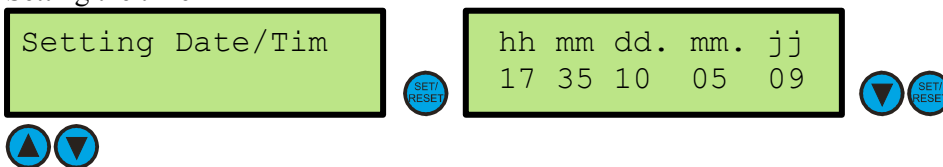

If the „Autostart“ function is selected, will start after switching on the mains or a power outage, the pump (s). Note: Pump may start unexpectedly!

Select „autostart“ function

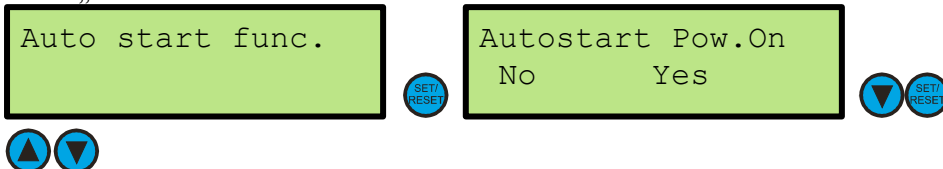

When „Safetystart“ funktion is selected, after switching on the Supply voltage or after a power failure the pump (s) in Security Mode automatically starts.(s). Note: Pump may start unexpectedly!

Select „safetystart“ function



Where have the arrow  - button after the last screen operated, we arrive at the desired values

7.3 Adjust set points





Notice: With the -button menu may be interrupted at any time.
The values are only for "internal" set point active!

Set points menu. Set points ads:

Give them get the correct code to set values in the menu.

Set points: Codeeingabe (___)

Set points:	Code input: 000
-------------	--------------------











Enter the target pressure of the system, a pressure, which is supposed to work the system.
 Target pressure of the pressure control

Target pressure	Target pressure: 04.00 bar
-----------------	-------------------------------











Enter the starting pressure of the system, a pressure, which will activate the system again.
 Start pressure value of pressure control with external „pressure setting“.

Start pressure	Start pressure: 03.80 bar
----------------	------------------------------





 



Enter the % value of the pressure monitoring one, in which the investment in water will turn off. The % value refers to the set pressure value. For example, 50% of 4.0 bar. The water is from <2.0 bar active and switches to 3 minutes delay from the pump. "If 100%" set, the water turned off monitoring.

"If 0%" set pressure monitoring switches off after 30 seconds to "dry run"

Pressure monitoring of the pressure control

Pressure control	Pressure control 100-0% 50%
------------------	-------------------------------------

Enter the differential pressure of the pressure regime for the master / slave setup book.
 Differential pressure of the pressure control (only Multi- pumps system)

Diff. pressure	Slave dif.press. 00.30 bar
----------------	-------------------------------











 

Enter the wait time, the pressure regime of FIXP - Operation book.

Wait time of pressure control (only FIXP - Operation mode in MAH-regulator)

FIXP-Wait time	FIXP-Wait time: 0-99sec. 01s
----------------	--------------------------------------











 

Enter the Fix speed value in Hz, where the plant is supposed to work in manual mode.

Fix speed value of the pump in manual mode setting: MAH, MAS2, MAK, MAY 30-99Hz, MAE 30-199Hz.

Fix speed freq.	Fix speed freq. 15-xxxHz xxHz
-----------------	---------------------------------------

Where have the arrow  - button pressed after the last display, we come to commissioning.

7.4 Start up menu

Notice: With the -button or  - button menu may be interrupted at any time.





Start up menu.

Display ads:

Code input:

Do they get the correct code into the startup menu.

Set points: Codeeingabe (___)





Start up  Code input: 000   





Rotating direction:

Enter the direction of rotation of the pump. Network phase does not matter!

direction of rotation of the pump

Rotating direct.  Rotating direct. Right Left   

Acceleration time:

Setting Time for Rate of Motor Acceleration. Recommendation: 1-3 seconds.

Acceleration time of the pump





Accelerate time  Accelerate time: 0-99sec. 01.0s   



 

Deceleration time:

Setting Time for Rate of Motor Deceleration. Recommendation: 2-10 seconds.

Deceleration time of the pump

Decelerate time  Decelerate time 0-99sec. 02.0s   





PID P gain:

Setting of P - amplification. Recommendation: 0,2-1,0.

Provides the rapid adjustment of the pump to the target pressure.





The P - Boost (**only MAH**) can improve the readjustment from the „standby“ significantly.

P gain of the pressure control

PID-P gain  PID-P gain: 0.2-5.0 01.0   





Setting of P - Boost amplification. Recommendation: 2,0-3,0.

Setting P-Boost (only MAH)

  P- Boost 0.2-4.8 04.8   

Setting of P - Boost frequency amplification. Recommendation: 35Hz.

Setting P-Boost frequency (only MAH)

  P-Boost frequency 15-99Hz 35Hz   

Where have the arrow  - button pressed after the last display, we come to commissioning.

PID-I time:

Setting Time for Integration. Recommendation: 0,5-2,0.
Provides the rapid adjustment of the pump to the target.

Setting Time for Integration

PID-I time

SET/RESET

PID-I time:
0.1-9.9s 01.0s

▲ ▼ SET/RESET

▲ ▼

Testing phase:

Provides for the safe shutdown in case of delivery "0". The test level manipulates the target pressure to continually check whether is encouraged. The larger the test mode, the safer the pump at promoting "0" turns. The **speed factor** and the **load factor** to form a mathematical shortcut.

The logic is:

$$\text{Actual pressure} = \text{target pressure} + \text{speed} < \text{speed factor} + \text{load value} < \text{load factor} = \text{Standby.}$$

That attitude can very well understand the expert page one.

For the setting of the system with load and speed factor is expertise required!

Enter the test level for zero flow cut off. Recommendation: 50%.

Setting Testing phase (P)

Testing phase

SET/RESET

Testing phase:
0-100% 50%

▲ ▼ SET/RESET

▲ ▼

Enter the Speed factor for zero flow cut off. Recommendation: 60%.

Setting Speed Factor

Speed factor

SET/RESET

Speed factor:
0-100% 50%

▲ ▼ SET/RESET

▲ ▼

Enter the Load factor for zero flow cut off. Recommendation: 50%.

Setting Load Factor

Load Factor

SET/RESET

Load factor:
0-100% 50%

▲ ▼ SET/RESET

▲ ▼

Leakage control:

Leakage Control identification of leakage in the pipe work. To enable this function set this menu item to „ON“ and select the numbers of allowed pump starts within 20 minutes; range: 01-15 starts within 20 minutes (fix time). If the pump starts more often then an error message will appear „Leakage failure“. This is normally only used on irrigation systems where frequent leaks are possible.

Switch On or OFF Leakage Control Function

Leakage control

SET/RESET

Leakage control:
Off On

▲ ▼ SET/RESET

Enter the number of pump starts this book. Recommendation: No numbers of pump starts

Starts in 20 min

SET/RESET

1-15 08

▲ ▼ SET/RESET

▲ ▼

▲ ▼

Where have the arrow - button pressed after the last display, we come to commissioning.

Run time control:

Run Time Control maximum allowed time of running. If pump runs longer than the set time it will stop and an error message will appear “Maximum running time”. If set to “OFF” this function is disabled.

Switch On or OFF Leakage Control Function



Enter the maximum duration for the pump. Recommendation: No

Maximum duration of the pump

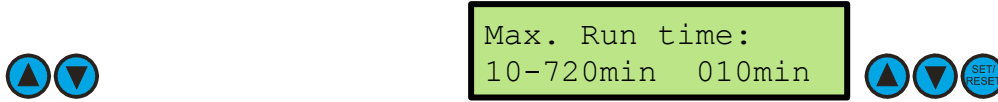

The submersible pump guard: (only MAH)

Provides for the safe shutdown of the pump at too low speed.

The function is to protect important marine engines prior to lower speed.

Turn on the switch for submersible pumps submersible pump operation.

Submersible pump guard operating

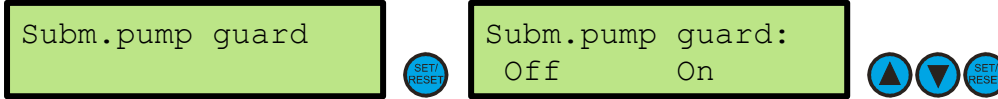

Enter the frequency of monitoring for the underwater pump.

frequency of monitoring for the pump

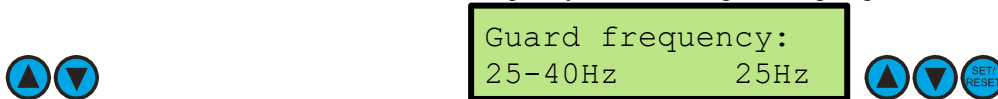

Enter the time for monitoring the underwater pump.

time for monitoring for the pump

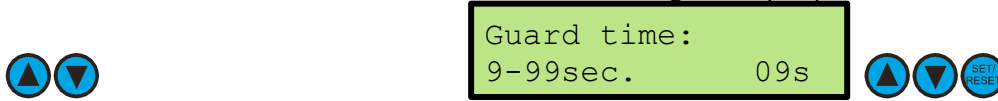

Transducer type:

Enter the transducer type for the pump controller. Data: See Nameplate transducer.

Transducer setting

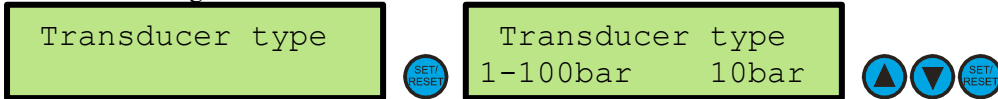

Active value input: (only MAH)

Choose from the signal input for the transducer. Data: See Nameplate transducer.

This feature gives you the option between 0-10V and 4-20mA signal to select.

Active value input of the pressure control

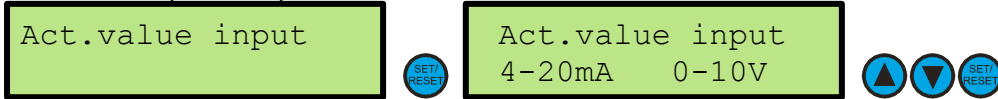

Where have the arrow  - button pressed after the last display, we come to commissioning.

Pressure setting:

Pressure mode setting

This feature gives them the opportunity to target pressure "internally" on keyboard or "external pretend" on a 4-20mA signal.

Pressure mode setting of the pressure

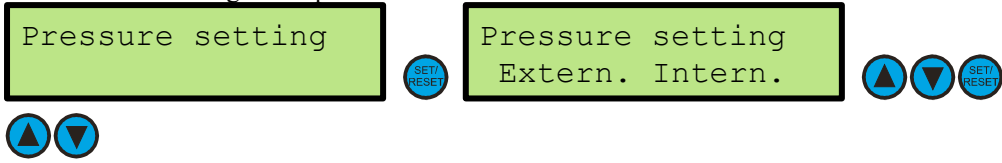

Running command:

Select the input for the start command of the pressure control.

The function gives them the opportunity to start command "internally" on your keyboard or "External" pretending via the terminal strip or "internally and externally" via the keyboard and terminal.

For "external and internal" selection appears an "E" as a status display when "Run" is active and the external input is opened.

„E" = External Off

Start command of the pressure control

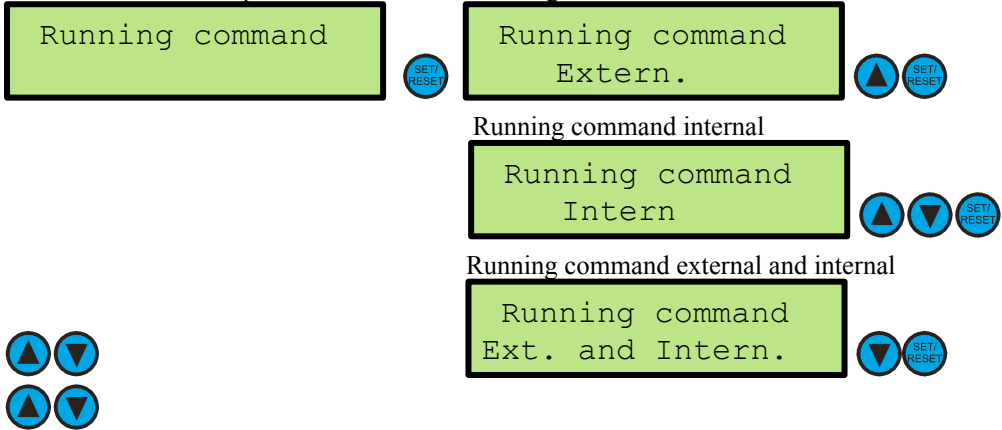



Limit function: (only MAH)

Turn on the limit function of the irrigation systems as needed "on".

If the limit function must be actively launched the Inverter - controller after each "stand" by the zero set off, with the external input "new limit". With this function, they prevent the irrigation systems a "dead run" of the pump after the end of irrigation.

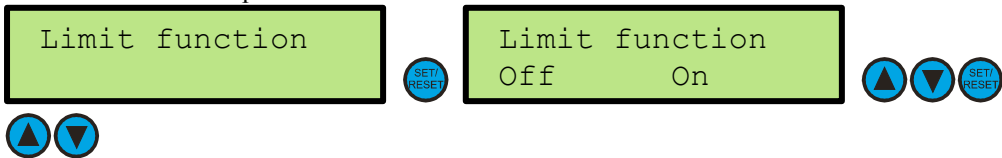
Limit function of the pressure control



Where have the arrow  - button pressed after the last display, we come to commissioning.

Low water function: (only MAH)

Select the input for the low of water pressure control.

The function gives them the opportunity to water "intern" with the pressure monitoring or "External pretend" through the terminal or "internally and externally with the pressure monitor and clamp. If "internal" selection active, with error message „127I low water“. The settings refer to the pressure monitoring. Is "external" selection is active and the external input is opened, the error message „130e low water“.

Low water function setting

Low water func.



External monitoring of low water

Low water func.
Extern.



Internal monitoring of low water

Low water func.
Intern



External and monitoring of low water

Low water func.
Ext. and Intern.



Relay function: (only MAH)

Choose from the relay function of pressure control.

This feature provides the communications for the optional relay 11 and relay 12 (option).

Caution: Depending on the technical execution of the relay can be blocked 11 or the relay 12 or the two relays 11 +12.

Relay Function setting

Relay function



Function for relay 11 internally (not for FIXP2 mode)

Relay 11
FU-intern



Function for relay 11 run signal (not for FIXP2 mode)

Relay 11
Run signal



Function for relay 11 sensor error (not for FIXP2 mode)

Relay 11
Sensor error



Function for relay 12 FU Sensor error (not for FIXP1/2 mode)

Relay 12
FU-intern.



Function for relay 12 FU internally (not for FIXP1/2 mode)

Relay 12
Run signal



Function for relay 12 sensor error (not for FIXP1/2 mode)

Relay 12
Sensor error



Function for relay 12 low water (not for FIXP1/2 mode)

Relay 12
low water



Where have the arrow - button pressed after the last display, we come to commissioning.

Auto reset function:

Select the reset function for the pressure control..

This feature gives them the opportunity to pressure control with automatic fault again start to leave. **Caution: The system runs automatically on again!**

Reset function setting

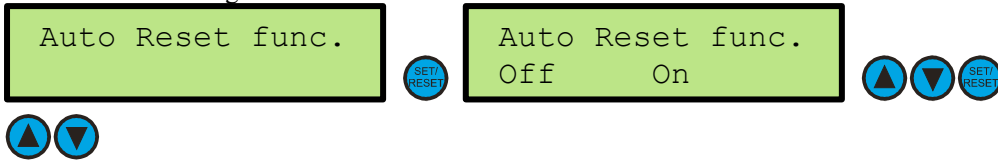

Operating mode:

Select the operating mode.

In the operating mode of the **single pump system** controller operates as a single unit.

In mode **multi pump system** can work two to eight (**only MAH**) pumps and multiple unit

This function is chosen, if the pumping plant consists of multiple pumps, all working in the frequency of pressure control. When multiple operating every **five hours of operation** are changed every 24 hours later than the pumps between master and slave. If a pump is not operating and at the same master, the pumps are switched from master to slave for about a minute.

Caution: For multiple pump sets: Each pump has its own display.

The same parameter changes must be made to all pumps/display

In FIXP mode function (**only MAH**), the master with frequency over the Relay output relay 11 and relay 12, one or two pumps down and out.

In FIXP1 function is used, the relay 12th. In FIXP2 function both relays are used 11 +12

Caution: In cases of FIXP - mode pump no change.

The relay 11 and relay 12 are closed for special functions.

Operating mode setting

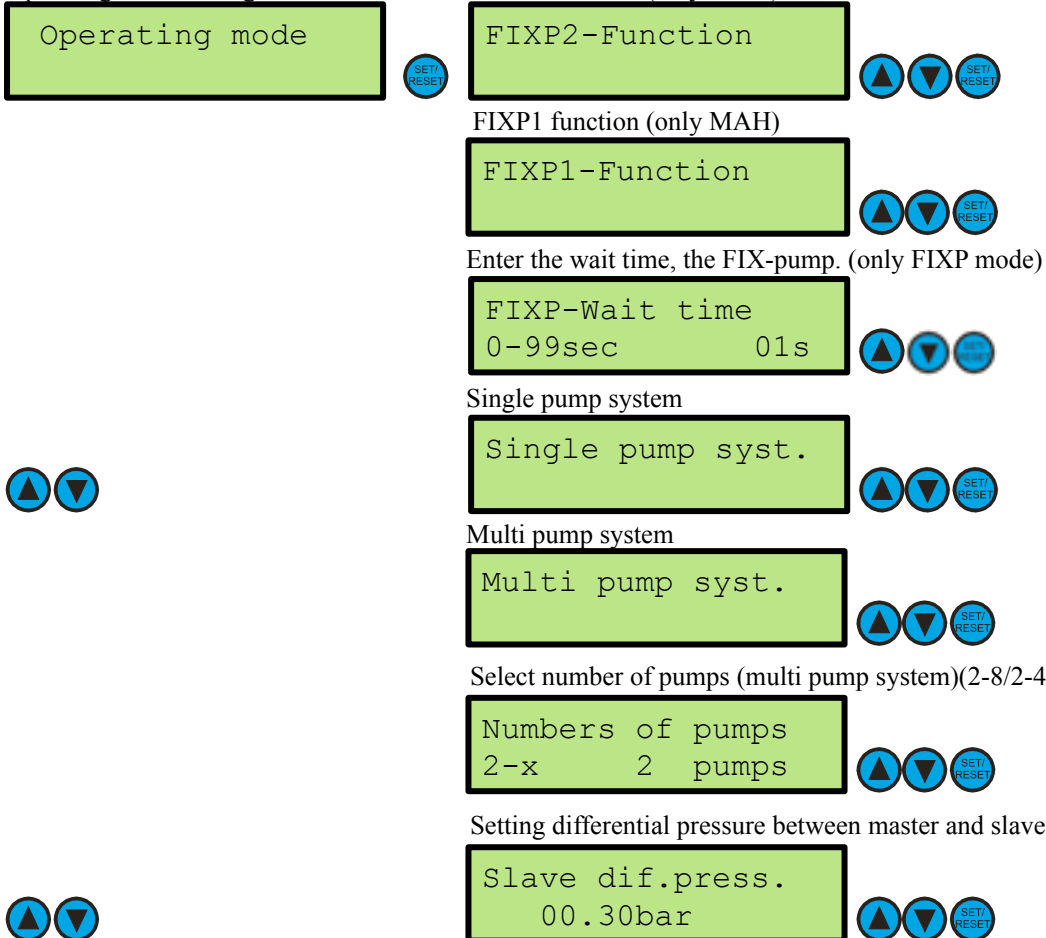

Where have the arrow - button pressed after the last display, we come to commissioning.

Motor rated current:

Setting rated f.l.c for the pump.

Motor Rated Current input actual current rating of motor as displayed on motor name-plate.

Setting rated f.l.c for motor

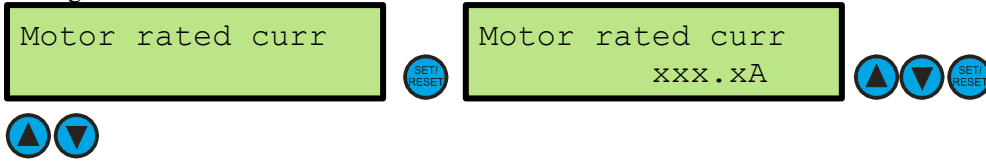

Current control:

Select motor overload control On or Off.

Current Control this function is used to prevent over current. If overload current is reached the frequency will decelerate the output current automatically. During set-up you may wish to disable this function temporarily.

Overload Current when the output current has reached the overload current the inverter will reduce the output frequency to prevent overload. If the current exceeds this value the pump will stop and an error message will appear “Overload”.

Recommendation: Set overload current 1.25 x Motor Rated Current

Select motor overload control On or Off

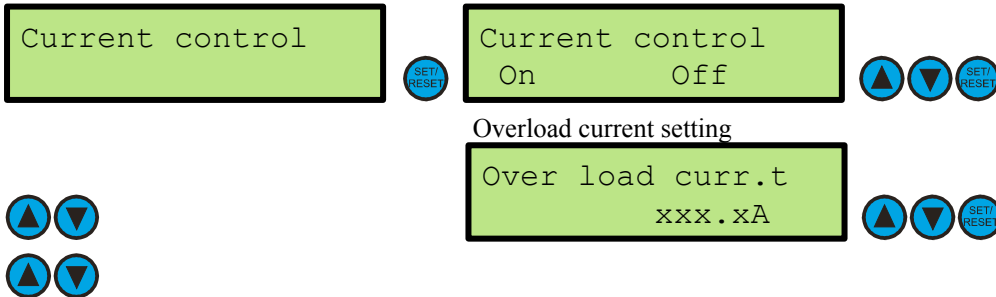

Carrier frequency:

Set inverter out-put frequency

Carrier Frequency this is the carrier frequency of the inverter output – high carrier frequency causes high temperature on the inverter and higher radio noise; lower carrier frequency causes higher motor noise and higher temperature in the motor. Set to obtain a balance between operating temperature and noise levels.

Recommendation: Factory setting: 3 kHz or 5 kHz (MAH, MAS2, MAK, MAE) or 9 kHz (MAI).

With this setting, approximately 95% of all controls are working.

Set inverter out-put frequency

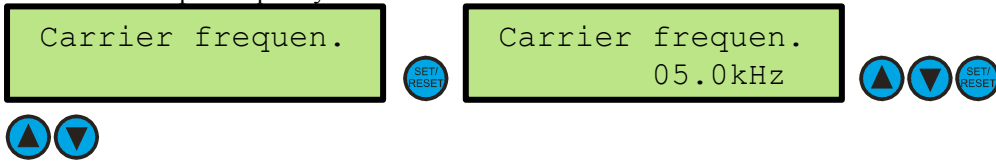



Motor pole selection:

Set the number of motor poles. Data: See Nameplate.

Motor pole selection e.g.: Rated motor speed 3000 rpm (29xx) = 2 pole

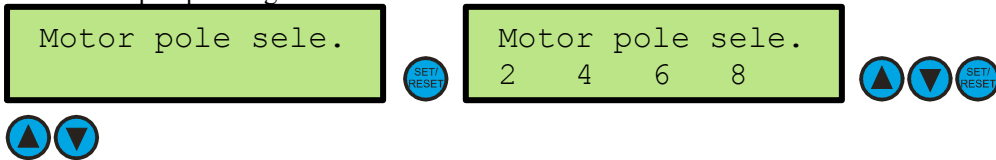
Poles of the pump setting



Where have the arrow  - button pressed after the last display, we come to commissioning.

Motor voltage:

Select the motor operating voltage
The setting data refer to the nameplate of the pump.
Select the motor operating voltage

Motor voltage	SET/RESET	Motor voltage: xxx-xxxV xxxV	▲	▼	SET/RESET
▲	▼				

Base frequency:

Set the base operating frequency. Data: See Nameplate.
With this function to enter the frequency of the pump.
Setting range: MAH, MAS2, MAK, MAI 30-99Hz, MAE 30-199Hz.
Set the base operating frequency

Base frequency	SET/RESET	Base frequency: 30-xxxHz 50Hz	▲	▼	SET/RESET
▲	▼				

Maximum Frequency:

Set the maximum operating frequency.
This feature allows them to enter the maximum frequency of the pump for operation. This possibility to adjust the pump performance can be limited.
Application: pumping with great support at a low pressure (system protection).
Setting range: MAH, MAS2, MAK, MAI 30-99Hz, MAE 30-199Hz.
Maximum operating frequency

Mixim.frequency	SET/RESET	Mixim.frequency 30-xxxHz 50Hz	▲	▼	SET/RESET
▲	▼				

Boost method:

Set the boost method.
The torque boost can improve the motor torque at low speed. If set to “automatic” torque boost the output voltage is adjusted automatically in-line with the condition of the load.
Recommendation: 0% for MAE, MAK, MAS2, MAI. Recommendation: 10% at MAH.
Boost method

Boost method	SET/RESET	Boost Method: Manuel automat	▲	▼	SET/RESET
		Boost factor			
		Boost factor: 0-xx% xx%	▲	▼	SET/RESET
▲	▼				
▲	▼				

Where have the arrow  - button pressed after the last display, we come to commissioning.

Torque Control: (not MAI - Variable-Speed motor)

Setting for motor characteristic. Constant: for borehole pumps. Quadratic for roto - dynamic pumps. This feature set allows them to motor characteristic for the pump.

With this function, the energy consumption of the pump can be changed. This function should be set by an electrical specialist or in consultation with the manufacturer.

Recommendation: Quadratic for centrifugal pumps, submersible pumps for constant.

Torque Control

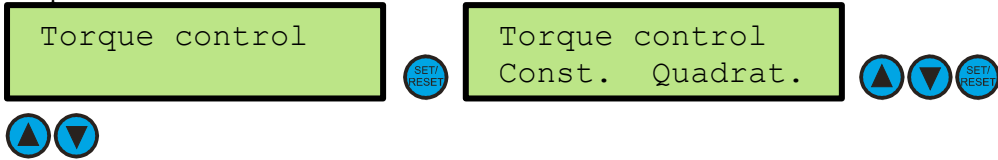

Energy saving mode: (only MAH)

They turn the power saving mode of inverter controller "On" or "Off".

This feature gives them the opportunity for long and smooth operation of the pump

To reduce energy consumption of the pump. This function should be set by an electrical specialist or in consultation with the manufacturer. Recommendation: None.

Energy saving mode setting

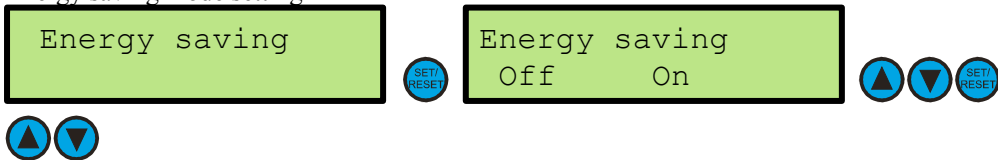

Test run:

Switch on/off Test run function.

if the pump has not started for 24 hours it will start at a selected time and run for a selected period as below. Operating frequency as frequency stored as "fix speed".

This function can prevent the permanent establishment of the pump.

Test Run

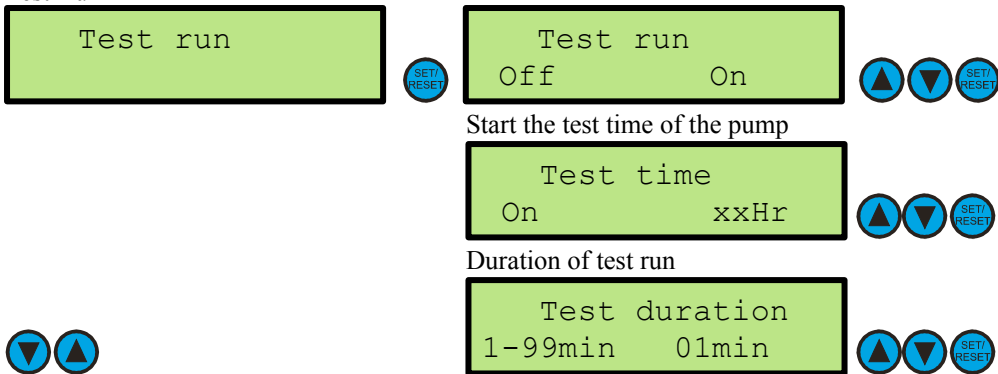

Select fire extinguishing mode (only MAH)



At present, no function (1/10)

Where have the arrow - button pressed after the last display, we come to commissioning.

Safety start:

Select safe start function

the event of a power failure only one pump will run at the pre-set frequency (below) for pre-set time (below) to allow the system to refill gently. This is a feature specific for tall buildings so as to prevent excessive surge pressure at the highest point on the pipe system.

Setting range: MAH, MAS2, MAK, MAI 30-99Hz, MAE 30-199Hz.

Safety start mode

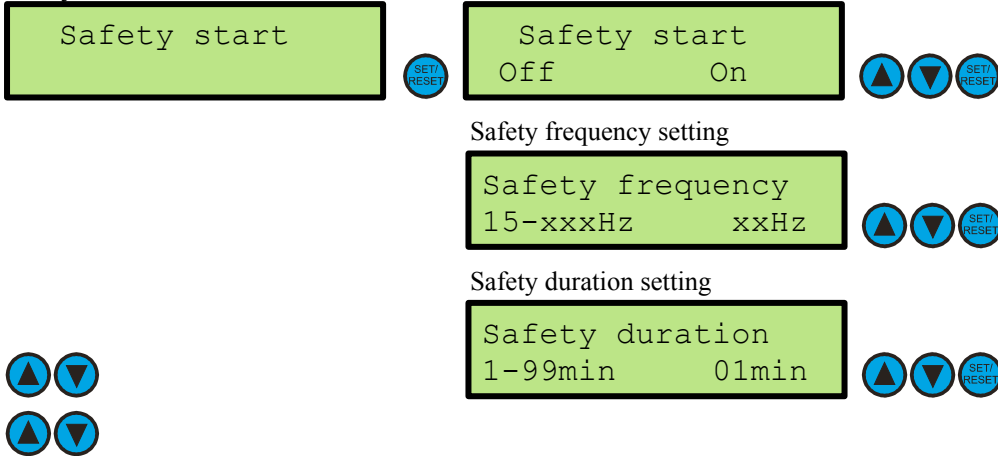

Pressure reduce:

Set the pressure reduce value in% for the pressure control.

Select if necessary, the pressure reduce for the pump on time.

This feature gives them the opportunity to reduce the energy consumption of the pump..

Set pressure reduction mode on or off

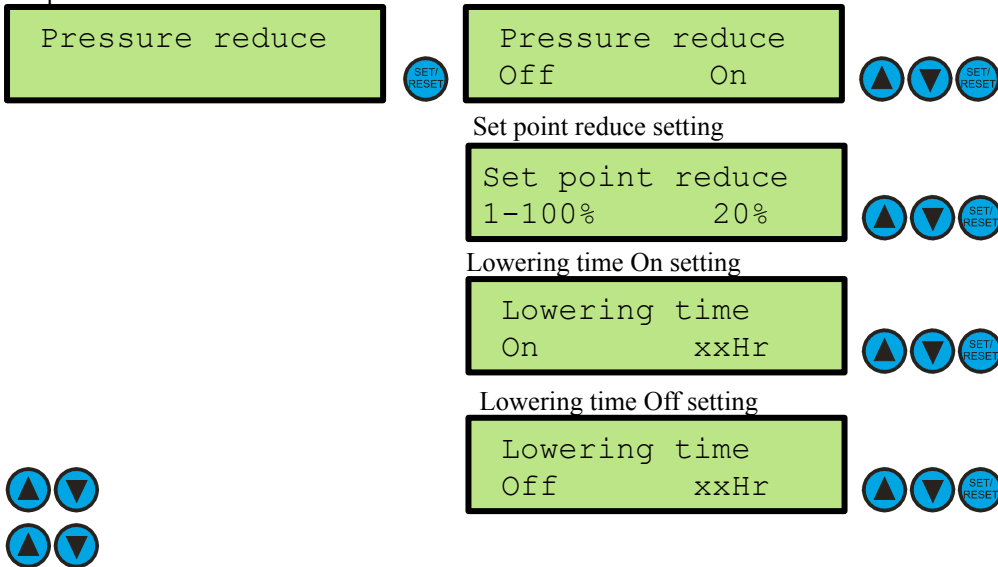

Menu language:

Choose operating language.

Choose between English and German.

Menu language

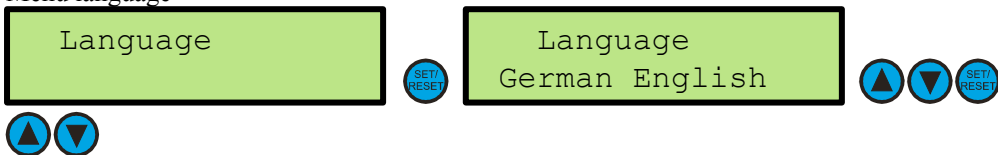

END of Menu

Notice: With the -button or  - button menu may be interrupted at any time.

8. Trip history monitor

8.1 Error indicators in the display

In case of failure, the frequency converter switches off and the pump is running independently..

Error messages can be reset by pressing the  button to reset by pressing

Error messages:

Fault: Overload

01 Const. speed
Over load > 200%

Motor overload (rotor lock) or short circuit condition
Promotes the pump too much?



Fault: Overload

02 deceleration
Over load > 200%

Motor overload when decelerating or short circuit condition



Fault: Overload

03 acceleration
Over load > 200%

Motor overload during acceleration or short circuit condition



Fault: Overload

04 Motor shutd.
Over load > 200%

Motor overload (rotor lock) or Motor cable broken short circuit at motor terminals



Fault: Motor protection

05 Motor thermal
Protection

Electronic motor protection activated. Motor overload/overheat condition



Fault: Zwischenkreis

07 Dynamo
Energy

Generator operation.
Check THE Non-return valve.
Service Call!



Fault: EEPROM

08
EEPROM - error

EEPROM error in the frequency inverters - Re - enter all parameters



Fault: Unterspannung

09 Phase error
/ Under voltage

Phase error or under voltage failure. Check fuses, check power supply voltage.



Fault: CT Offset

10 CT Offset

CT Offset
Incorrect input directly on the drive. Service Call!



Fault: CPU

11 CPU
Error

Radio interference to drive.
Check the cable, remove the source of interference.



Fault: External trip

12
External trip

External fault with digital input.
External eliminate errors.



Error messages:

Fault: Emergency

13 Emergency
Stop

Restart was entered directly
on the drive.
Service Call!



Fault: Ground

14 Motor
Ground fault

Earth/Ground fault at motor
Cables, connectors, engine test
for ground fault.



Fault: Power supply

15 Power supply
Over voltage

Network voltage too high
Service Call!



Fault: Power supply

16 shortly
Power failure

Short power failure.
Tighten connections,
Voltage test.



Fault: Inverter

21 IGBT-
Overheating

Inverter gets too hot. Carrier
frequency reduced.
Cooling system broken?



Fault: Inverter

23 FU
Internal error

Frequency defective.
FU exchange.
Service Call!



Fault: Phase

24
Phase error

Phase loss.
Check fuses.
Voltage test.



Fault: Inverter

30
IGBT - error

Short circuit to drive.
Cables, connectors, engine
check. Service Call!



Fault: Inverter

31
IGBT - error

Processor error in the frequency
inverter - exchange inverter
Service Call!



Fault: Motor

35
Thermistor error

PTC triggered -
Motor overload.
Test the PTC.



Fault: Sensor

63 Sensor error
Fix speed ?

Failed sensor or pressure
<= 0.10 bar. Check sensor.
Fix speed is available!



Fix speed: If it is necessary, the pump (s) to operate with a fixed speed () such as a breakdown of the sensor can activate the "fix speed".

Once the menu item „fix speed“ with the -key has been selected, displays a blinking cursor.

With the cursor key  or  on „ON" and confirm with key .

The manual operation is activated immediately. The frequency with which the pump is in manual mode, it can - as described below - are set.

The pump (s) works when there is the start command RUN ( - button). („External start" even possible!)

To disable the manual mode again: press  - button for 2 seconds.

Fault: Low water internal (only MAH)

127i
Low water

Pumps operating outside parameters - Hydraulic overload
- Option to select fixed speed



Fault: Low water external (only MAH)

130e
Low water

External actual pressure is too small or Tank is empty!
External signal check.



Fault: Low water (only MAS2,MAK,MAE,MAI)

127
Low water

Pumps operating outside parameters - Hydraulic overload
- Option to select fixed speed



Fault: Dry run

135
Dry run

Actual pressure less than 0.50 bar or Dry run!
Water level check.



Fault: Running time

143
Max running time

The maximum pre-set running time reached -
plant shut-down



Fault: submersible pump

144
Subm.pump error

Submersible pump works with less than 30 Hz for longer than 3 minutes. Increase water loss.



Fault: Leakage

159
Leakage failure

The maximum number of pre-set starts has been reached -
plant shut-down



Fault: Connection in multi mode

175
Junction error

Connection of the FU-control in the multi mode is disturbed?
Service Call!



In a Junction error is automatically reset to rebuild, for 25 times in 60 minutes, until done to the error message.

Fault: Inverter

255
Other error

Un-coded error recorded
Connection to the / FU in disturbed? Service Call!



Error messages can be reset by pressing the  - button or by a short external control of the terminal „Fix speed“ / „Reset“.

8.2 Reset the operating hours

To reset the operating hours to **00000** the following procedure:

When you turn and during the communication-building:

The arrow  +  + the set / reset  - buttons simultaneously and hold!

It appears this message on the display:

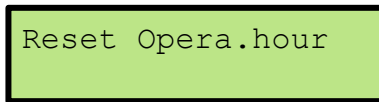

Reset Opera.hour

If unsuccessful repeat the process.

8.3 Fault memory

Is operated by the menu page "operating hours", the  - button, so you get the error memory. Here you can apply retroactively the last 1-6 error messages with date and time at the time of the error are read.

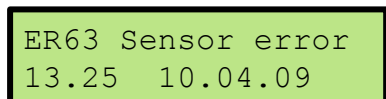

Example:
Time: 13.25

Error number 63 "sensor failure"
clock on 10-04-2009.



ER63 Sensor error
13.25 10.04.09



Use the arrow keys  and  is between the errors, inasmuch as there are several mistakes, be able to scroll back and forth.

Be actuated by the failure of memory, the  -button to return to the main display.

8.4 Trouble-Shooting

Monitor is dark

Power supply is on?
Check fuses!

Pump does not start running

Run command is not given?
If RUN key is used: press RUN button (see "R" in display).
If "external run" is used: close "+24V" and "Ext.1".

Pump does not start running but display shows "R" (running command)

Pressure transducer is not connected?
Pressure in pipe is higher than set target pressure?

Pump does not stop

Set target pressure is too high (pump can not reach pressure)?
Pipe work is not ventilated properly? Non-return is passing?
Set "water stop identification" to a higher value!
Testing level not set correctly? ***See: test level, load factor, speed factor!***
In short rigid pipe to check the expansion tank into the pressure line after installing the Non-return valve (pre-squeezing pressure: nominal pressure - 0.5 bar)!

Pressure monitor does not show the right pressure

Factor for "transducer type" is wrong (e.g., 10 bar - Sensor, 25 bar - sensor)?
Transducer plug is wet?
Transducer cable is faulty?

Panel becomes to warm

Check ambient temperature! Provide cooling airflow!
Set "carrier frequency" to a lower value!

Display shows no data and pumps do not start

Connected pumps have the "network" already switched ground fault.
Disconnect pump and check for possible ground fault.
Frequency control without pumps connected to functional test

9. Expert mode

9.1 FIXP - mode only MAH-controller with one frequency inverter

In FXP - mode one or two pumps can be "fixed" with be controlled.

Prerequisite:

All pumps move into a common discharge line. Behind each pump is a spring-loaded Non-return preventer. A pressure sensor is mounted in the same pressure.

The FIXP - consists of a control knobs and a solid or two pumps. The "fixed" pump (s) are connected via the relay outputs 11 and 12. The "fixed" pump (s) are operated via contactor or soft starter.

In FIXP1 function, the option relay 12 is used.

In both Option FIXP2 function relays used to be 11 +12.

The individual pumps are used to depending on the demand for water and off.

The plant remains in operation if one pump is turned off.

Changes in the parameters must be entered for all the pumps on the same screen!

9.2 Multi-mode with all controls with a frequency inverter for each pump

Multiple pump system can be set to the MAH for 2 to 8.

Multiple pump system can be set to the MAS2 for 2 to 4.

Multiple pump system can be set to the MAI for 2 to 4.

Multiple pump system can be set to the MAK for 2 to 4.

Multiple pump system can be set to the MAE for 2.

Prerequisite:

All pumps move into a common discharge line. Behind each pump is a spring-loaded Non-return preventer. A pressure sensor is mounted in the same pressure.

The multi-systems consist of several controllers, each working independently! Each pump has its own PID controller. **Depending on the model, one or more pressure transducers may be present.**

The terminals for the transducers are correspondingly available

The individual pumps are used to depending on the demand for water and off.

The controller is calculated from the programmed target pressure, release pressure and the pressure difference, the operating values of the respective pump.



Notice!

Notice

For multiple pump sets: Each pump has its own display.

The same parameter changes must be made to all pumps/displays.



Caution!

The difference between set pressure and release pressure must be less than the difference in pressure!

The plant remains in operation if one pump is turned off.

Changes in the parameters must be entered for all the pumps on the same screen!

Example of a 3 pumps system with:

4.0 bar target pressure, 3.8 bar start pressure and 0.3 bar differential pressure release pressure:

Master	Slave 1	Slave 2
SO 4.00 ST 3.80M S1 0.00 LF00 DF00	SO 3.70 ST 3.50S1 S1 0.00 LF00 DF00	SO 3.40 ST 3.20S2 S1 0.00 LF00 DF00

9.3 Pump changeover

Which of the pump first starts, is not defined. To ensure a smooth operation of the pumps, it is every **5 hours or at least every 24 hours of master / slave** changed - operational.

The controllers are interconnected by a communication line. A controller is halted or falls out due to a defect, will be relayed to the master status after one minute.

The communication line is interrupted, the error message "Junction error"

Fault: Connection in multi mode

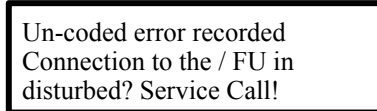
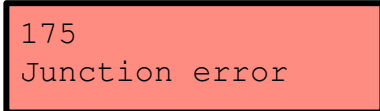

In a Junction error is automatically reset to rebuild, for 25 times in 60 minutes, until done to the error message.

9.4 Forced pump changeover

For service purposes, the pump can be forced to change, it will stop in which the respective master. By stopping the master status is relayed to a minute. The governor, who is now a slave, is launched. Now this can be done in the same way until the chain fully tested with the new master is.



Caution!

The communication line (junction) is interrupted by the following criteria:

- Fix speed is active
- The programming process is not completed with a knob
- Junction error

With interrupted chain of automatic pump switch is broken!

9.5 Zero flow cutoff (Testing phase)

Ensures the safe shutdown in case of water quantity "0".

The „zero flow cutoff“ demands for the setting a bit of experience and detailed knowledge of the functioning of the regulator. If the site with the default setting of „zero flow cutoff“ is not working satisfactorily, please contact a dealer or manufacturer.

Testing phase (P): 0..100% 50% Recommendation: 50%.

Provides for the safe shutdown in case of delivery "0". The test level manipulates the target pressure to continually check whether is encouraged. The larger the test mode, the safer the pump at promoting "0 turns.

The **Speed factor** 0..100% 50% Recommendation: 60%.
and the **Load factor:** 0..100% 50% Recommendation: 50%.

to form a mathematical shortcut.

The logic is:

Actual pressure = target pressure + speed < speed factor + load value < load factor = Standby.



That attitude can very well understand the expert page one.

Notice!

For the setting of the system with load and speed factor is expertise required!

Example:

Pump operates at 45% load (LF). The speed (DF) is 82%. The pressure is compensated (S0). The testing phase (P) increases. The current value is currently 145.

P	145	LF	45	50
S0	3.17	DF	82	50

Pump is available with 00% load (LF). The speed (DF) is 00 %. The pressure is compensated (S0). The testing phase (P) stands. The current value is currently 000.

P	000	LF	00	50
S0	3.52	DF	00	50

10. Clear presentation of the menu structure MA.... Version 7

Display ads: >>>>

Display	Fault memory	(1-6)	
Display	Operating hours		
Display	Experts page 2	(only Multi mode)	
Display	Experts page 1	(Expert mode)	
Display	Speed, motor current I		
Display	Pressure, Date and time		
Display	Pressure, Output Frequency		(Main Display)
Fix speed	On/Off		
Setting time / date	Setting the time		
Autostart function	Autostart power on	No / Yes	
Safetystart function	Off / Ein		

Set points: >>>>	Code input (___)	Factory settings:
Target pressure	0.01 - 99,99 bar	4.00 bar
Start pressure	0.01 - 99,99 bar	3.50 bar
Pressure control	0 - 100 %	50%
Difference pressure	0.01 - 99,99 bar (only Multi mode)	0.30 bar
FXP- Wait time	0-99 sec. (only FIXP- Betrieb)	1 sec.
Fix speed	15 - 99 Hz (15-199Hz)	35Hz

Start up: >>>>	Code input (___)	
Rotating direction	Right / Left	Right
Acceleration	0.1 - 99 sec.	1.0 sec.
Deceleration	0.1 - 99 sec.	2.0 sec.
PID-P gain	0.2 - 5	1.0
P- Boost	0.2 - 4.8 (MAH)	2.0
P- Boost frequency	15-99 Hz (MAH)	35 Hz
IPID-I time	0.1 - 99 sec. (MAH)	1.0 sec.
Testing phase	0-100%	50%
Speed factor	0-100%	50%
Load factor	0-100%	50%
Leakage control	Off / On	Off
Starts in 20 min	1-15	08
Run time control	Off / On	Off
Maxi. Run time	10-720 Min	10 Min
Submersible pump guard	Off / On	Off
Transducer type	1- 100 bar	10 bar
Active value input	4-20mA / 0-10V	10 V
Pressure setting	internal / external (analog 02)	internal
Running command	internal / external / internal and external	internal
Limit function	Off / On	Off
Low water function	internal / external / internal and external (MAH)	internal
Relay function	Relay 11 FU-intern / Run Signal / Sensor error	FU-intern
	Relay 12 FU-intern / Run Sig. / Sen. error/ low water	FU-intern
Auto Reset function	Off / On	Off
Operation mode		
FIXP2- Funktion/ FIXP1- Funktion /FIXP- Wait time	0-99 sec.	1 sec.
Single pump system		Single pump
Multi pump system		Multi pump
Numbers of pumps	2 - 8 (2-4) (2)	2
Difference pressure	0.01 - 99,99 bar	0,30 bar
Motor rated current	xxx.x A	inverter value
Current control	On / Off	On
Overload Current	xxx.x A	inverter value
Carrier frequency	0,5-10 kHz	inverter value
Motor pole selection	2 / 4 / 6 / 8	2
Motor voltage	xxx-xxx V	inverter value
Base frequency	30 - 99 Hz (30-199Hz)	50 Hz
Maximum Frequency	30 - 99 Hz (30-199Hz)	50 Hz
Boost Method	Manuel / Auto	Manuell
Boost	0-20%	inverter value
Torque Control	Constant / Quadratic (no MAI)	Constant
Energy saving	Off / On (MAH)	Off
Test run	Off / On	Off
Test time:	On xx Hr	10 Hr
Test duration:	1 - 99 min	1 min
fire extinguishing	Off / On	Off
Safety start	Off / On	Off
Safety frequency	15 - 99 Hz (15-199Hz)	30 Hz
Safety duration	1- 99 Min	1 Min
Pressure reduce	Off / On	Off
Set point reduce	1 - 100 %	20 %
Lowering time	On xx Hr	17 Hr
Lowering time	Off xx Hr	18 Hr
Language	German / English	English

End of menu

11. Customer Settings

Customer Settings	from:	_____
Target pressure	4.00 bar	_____
Start pressure	3.50 bar	_____
Pressure control	50%	_____
Difference pressure	0.30 bar	_____
Fix speed	35Hz	_____
Rotating direction	Right	_____
Acceleration	1.0 sec.	_____
Deceleration	2.0 sec.	_____
PID-P gain	1.0	_____
P- Boost (MAH)		_____
P- Boost frequency (MAH)		_____
PID-I time	1.0 sec.	_____
Testing phase	50%	_____
Speed factor	50%	_____
Load factor	50%	_____
Leakage control	Off	_____
Starts in 20 min	08	_____
Run time control	Off	_____
Maxi. Run time	10 Min	_____
Submersible pump guard	Off	_____
Transducer type	10 bar	_____
Pressure setting	internal	_____
Running command	internal	_____
Operation mode	Multi mode	_____
Numbers of pumps	1 - 8 (2-4))(2)	_____
Motor rated current	xxx.x A	_____
Current control	On	_____
Overload Current	xxx.x A	_____
Carrier frequency	kHz	_____
Maximalfrequenz	050 Hz	_____
Torque Control	Constant	_____
Test run	Off	_____
Test time:	10 Hr	_____
Test duration:	1 min	_____
fire extinguishing	Off	_____
Safetystart	Off	_____
Safety frequency	030 Hz	_____
Safety duration	1 Min	_____
Pressure reduce	Off	_____
Set point reduce	20 %	_____
Lowering time	17 Hr	_____
Lowering time	18 Hr	_____